

**THE OPTIMAL**  
Solution of Medical  
Outdoor Chiller

MC CHILLER  
**DEVELOPED FOR**  
THE HIGHEST DEMANDS

医用冷水机组 最优室外机解决方案



**GLENDIMPLEX CHINA**

沈阳市浑南区世纪路9号  
No.9 Shiji Road, Hunnan Industrial Zone,  
Shenyang, Liaoning, PR China.

**CONTACT NO.**

+86 24 23782259-8045

**EMAIL**

sales@gdts-one.cn

www.gdts-one.cn



# Company

## Product Overview 产品介绍

适合

亚太区域的制冷产品

riedel<sup>o</sup>  
kooling

制冷量从 10kW-100kW

Cooling capacity 10 kw to 100 kw

理想化、稳定化

Idealize and stabilize

独特的节能性及经济性

Unique energy-saving and economical

There were unlimited options for building an innovative new chiller. We simply chose the best.

随着 MC 系列产品的推出, RIEDEL 正致力于扩展亚太地区业务, 尤其关注医疗系统中的节能和可靠性两方面。MC 产品的制冷量从 10kW-100kW, 可以为医疗设施中现代诊断器材提供理想的、稳定的运行环境。

在系列产品研发过程中, 我们将系统稳定和快速而精准的制冷作为技术研发的重点。为了满足医疗系统不间断运行的高标准, 我们精选零部件, 并采用高标准的设计原则, 保证您的设备稳定运行, 出众的技术理念让设备在满足噪声控制标准的同时, 在节能和低成本方面也实现了突破。

Developed for ASIA-PACIFIC business.

With the launch of MC series RIEDEL is expanding the business in ASIA-PACIFIC area. We are particularly focus on the energy-efficient and reliable series for medical system. Facilities range from 10 to 100kW ensure ideal operation condition for modern diagnostic devices in medical facilities.

RIEDEL Competence - Our commitment

During development of this series, the focus was on extremely system stability operation and effective cooling within narrow tolerance limits. For this reason, the selected components and the design principle were precisely adapted to meet the high requirements of continuous clinical operation. The technical concept of the units meets the high requirements of noise emission control and is both ecologically and economically ground-breaking.

# HIGH COST PERFORMANCE

## HIGH OPERATION

性价比高，高运行

We have a clear picture of the requirements of your equipment.

更了解客户的需求

我们设计的产品可满足 -25°C到 +40°C的环境温度，要达到这个温度范围，需满足多重设计条件，包括成熟的设计理念，以及来自顶级供应商的兼容零件等。

MC series design can be used at outside temperatures range from -25 C to +40 C. This is ensured by various factors, including the robust design and the perfectly compatible components sourced from best of its class suppliers.

### Remarkably quiet and unobtrusive

在噪音输出方面，MC 系列制冷机即使在全负载状态下也能达到安静地运行。

## PRODUCT PERFORMANCE

### 产品特点

高效节能：在夜间模式下 - 只有氨压缩机运行时，一个制冷压缩机工作可保证设备正常运行；

High efficiency in the night mode: One compressor can guarantee minimum performance that the MRI is cooled.

可支持 2 个水泵自动切换，延长水泵使用寿命并能使冷水机更加稳定；

Auto switch is available between 2 pumps, which can extend the lifetime of the pump and make the chiller more reliable.

低噪音设计：可调控的速度能在极大程度上减少噪音；  
Remarkable quiet design: The speed-controlled reduce extremely the sound level.

整体设计紧凑，所需安装空间小；  
Compact design: The chiller needs a small footprint and is quickly installed.

闭式系统，内置换热器、水泵、水箱、膨胀箱等。  
Complete water circuit: The chiller has all necessary parts inside ( heat exchanger, pump, tank, vessel tank etc.). This makes a highly effective and easy installation possible.



Maximum possibilities at minimum lifecycle costs

该系列最大制冷量可达100kW，同时拥有低噪音及性价比高的优势。

Cooling capacity of this MC series go up to 100kW. The units are exceptionally quiet and have impressively low lifecycle costs.



MC Chiller  
MC 冷水机

最大制冷量可达 100kW  
The maximum cooling capacity can reach 100kW



制冷  
Refrigeration

# APPLIED AMBIENT TEMPERATURE

DEDICATED TO THE ASIA-PACIFIC REGION

-25°C到+40°C的应用环境温度专为亚太地区设计的制冷理念

A chiller for the most extreme climate zones.

RIEDEL 使用 R407c 及 R134A 制冷剂，为医疗产品提供全系列的解决方案。  
RIEDEL use refrigerant R407c and R134A to provide overall cooling solution for MRI.

For use at ambient temperatures between



AMBIENT  
TEMPERATURE - 25°C



AMBIENT  
TEMPERATURE +40°C



使用 R407c 及 R134a 制冷剂

Use R407c and R134a refrigerant

Cooling concept for ASIA-PACIFIC region.

The performance capacity of cold water units depends primarily on the refrigeration design and the refrigerant used. RIEDEL has decided to use the advantages of the high-performance R134a for the MC series – the unit therefore provides a universal solution.

制冷量的稳定程度是由最初的制冷回路设计和制冷剂决定的。RIEDEL 在 MC 系列产品中使用高效的 R134a 和 R407c 制冷剂，可以提供更多通用解决方案。

# CONTROL SYSTEM CONFIGURATION

## INTELLIGENT CONTROL SYSTEM

### 智能化控制系统

Excellently connected and always easy to reach.

#### RIEDEL 控制板 & 显示屏

RIEDEL 控制板 (RCB) 包含一个 RIEDEL 特定的调节器和控制单元, 以及 RD2 和 RD3C 显示器。控制器和显示器独立设计的好处在于: 控制面板可以安装在非常小的空间, 如果有特殊需求也可以由其它操作单元代替。这个系统的核心是 STAR 模块。RIEDEL RCB 包含所有控制元件以及以下特征:

- 可以模拟高精度的温度以及压力信号频道
- 高速数字信号脉冲输入
- 高抗干扰度
- 内外部网络的 ST-Bus
- 远程启动
- 泵控制程序
- 压缩机控制程序
- 风扇控制程序
- 限值监控
- 缺水 / 干运行保护
- 保养信息
- 选配: 现场总线 Profibus, CAN-Bus, 以太网 Ethernet, GSM

#### RIEDEL Controller Board and RIEDEL displays

The RIEDEL Controller Board (RCB) consists of a RIEDEL-specific regulating and control unit and the RD2 and RD3C operating displays. The separation of the controller and the display unit offers several advantages: The control panel can be installed taking up a minimum of space, and if required, can also be replaced by other operating units. The core of this system is the STAR-Module. The RIEDEL RCB contains all important control elements and has the following features:

- Highly accurate analogue channels for temperature and pressure signals
- Pulse inputs for rapid digital signals
- High interference immunity
- ST-Bus for internal and external networking
- Remote start
- Pump control
- Compressor control
- Fan control
- Limit value monitoring
- Protection against water shortage/dry running
- Maintenance message
- Options: Profibus, CAN-Bus, Ethernet, GSM

## OPERATING DISPLAY

### 运行显示器

The following operating displays are possible:

- 标准 RD2: LED 显示器, 可显示出水温度和设备状态信息。
- 远程控制器 RD3C: 可允许远程控制以及远程网络诊断, 设备是一个 4.3" TFT 彩色触摸屏。RD3C 显示器可通过浏览器和手机端进行访问。
- 数据网络: RCB, RD3C 与冷水机的交互



**Standard RD2:** LED displays with the outlet temperature and equipment status information.

**Remote control RD3C:** The display allows for remote control and remote diagnosis of networked coolers, equipped with a 4.3" TFT colour graphics touch screen. The RD3C display can also be accessed from around the world using a browser or a smartphone. ▲ RD

**Data networking:** Chillers with RCB and RD3C

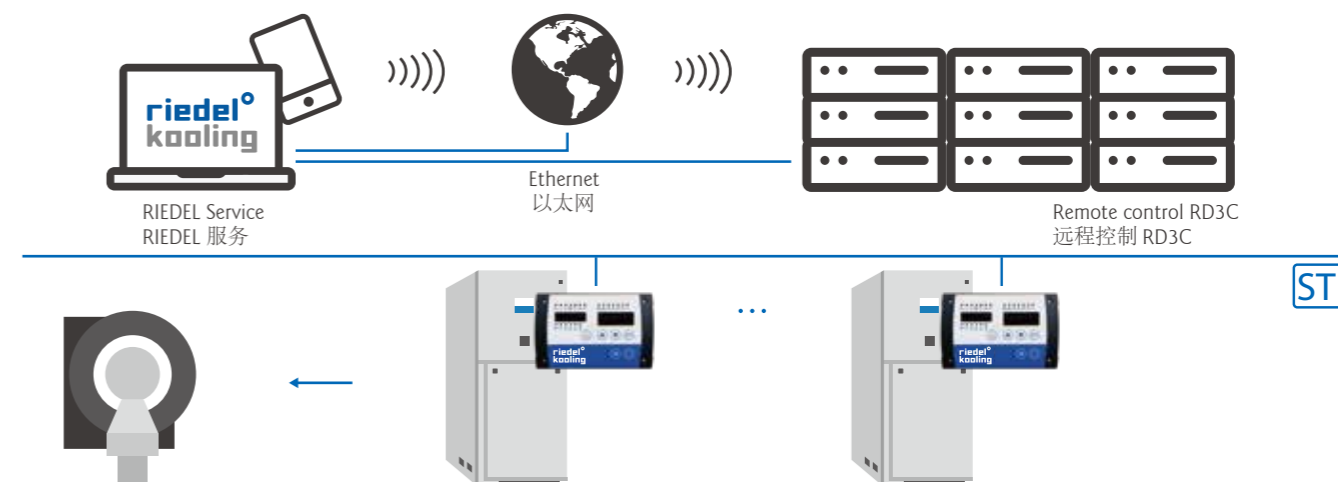

# Excellent Technology

## COMPELLING TECHNOLOGY

### 产品参数及安装

All Dimensions In mm 尺寸 (mm)

以MC670AS为例  
Take MC670AS as an example

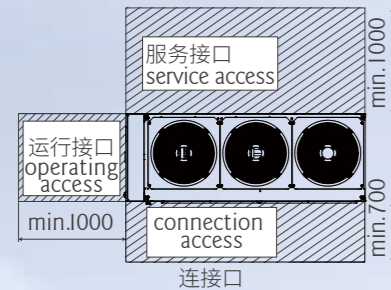
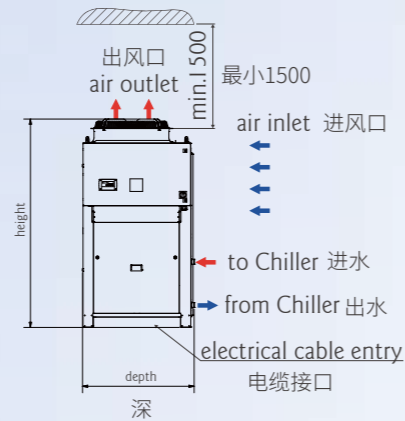
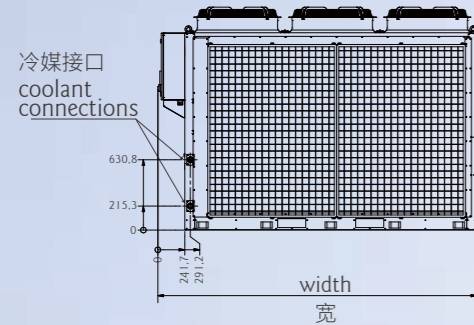

\*以上数值仅供参考  
The above data is only for reference

① tw2 = 10 °C; ambient temperature tu = 40°C (refrigeration capacity incl. pump power loss)  
tw2 = 10 °C; 环境温度 tu = 40 °C (制冷能力包含泵功率损失)

② testing point is 10m away from the unit  
测量点距离被测机组 10 米

Technical data			
Series		MC670AS	MC649AS
Refrigerant 制冷剂		R134a	R407C
Coolant fluid 载冷剂		乙二醇水溶液 Glycol-water mixture (40:60)	乙二醇水溶液 Glycol-water mixture (40:60)
Net cooling capacity <sup>1)</sup> 制冷量	kW	70	49
Coolant outlet temperature 出水温度	°C	10°C	10°C
Accuracy 精度	K	+/-2	+/-2
Ambient temperature, max. 最大环境温度	°C	40	40
Altitude 海拔		1000	1000
Ambient temperature, min. 最小环境温度	°C	-25	-25
Flowrate coolant 流量	m³/h	7.8	7.8
Available pump pressure 可供扬程	bar	3.5	3.5
Water connections 水连接方式	G	RI 1/2" external thread外螺纹	RI 1/2" external thread外螺纹
Tank volume 水箱容积	l	80	80
Tank type 水箱类型		Close封闭式水箱	Close封闭式水箱
Air volume flow at ambient conditions 风量	m³/h	33000	22000
Rated supply <sup>2)</sup> 额定供电电压	V/Ph/Hz	380 ± 10 % / 3 / 50 ± 1.5	380 ± 10 % / 3 / 50 ± 1.5
Rated power consumption <sup>1)</sup> 额定耗电量	kW	48	35
Rated operating current <sup>1)</sup> 额定运行电流	A	91	66
Sound pressure <sup>2)</sup> level-Full load 噪音等级 (满负载)	db(A)	61	61
Sound pressure <sup>2)</sup> level-Partial load 噪音等级 (小负载)	db(A)	54	49
Dimensions for transport (W x H x D) 包装尺寸	mm	3050x2220x1200	1170x2220x2500
Dimensions (W x H x D) 机组尺寸	mm	2860x2000x1070	1070x2000x2400
Weight for transport 毛重	kg	1080	820
Weight (empty) 净重	kg	1000	710
Qty of Compressor 压缩机数量		4	3
Qty of Fan 风机数量		3	2
Qty of Pump 水泵数量		1 or 2	1 or 2

## PLANNING INFORMATION

### 规划信息

- 建议的机组安装距离，安装管最长可达 60m
- 高度差是 0 时，安装距离可达 60m
- 高度差是 30 米时，安装距离是 30m
- Installation distance for 2" pipe dimensions:
- 60 m for 0 m elevation
- 30 m for +/-30 m elevation

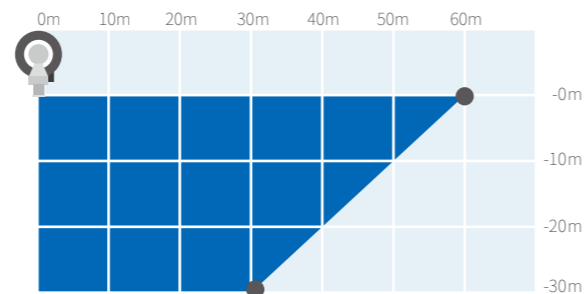

## Accessories

### 附件

模块化系统：有多种选择可供功能扩展

Modular system: There are numerous practical options for extending the range of functions, comfort and safety of the MC series.



**1- 远程控制板**  
Remote control panel



控制室监控和操作冷水机  
Monitoring and operation of the chiller from the control room.

**2- 紧急供水模组**  
Emergency water supply module

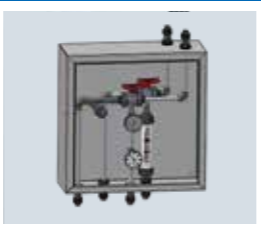

在维修和紧急情况下，可通过连接生活用水网络给氦压缩机持续制冷  
Alternative water supply for the helium compressor via the drinking water network in the event of maintenance work or power blackout.

**3- 防震组件**  
Anti-vibration kit



弹性垫可防止机械振动  
The elastic bedding of the cooling unit prevents disruptive mechanical vibrations.

**4- 乙二醇**  
Glycol-water mixture



预先配比好的乙二醇水溶液方便使用及调试，适用温度为 -25~40°C。  
The pre-mixed glycol, ready to use for a quick and easy commissioning, is usable at the temperature range of -25°C to +40°C.

**5- 过滤组件**  
Filter kit



高效分离固体杂质  
Effective elimination of solid matter from the cooling circuit.

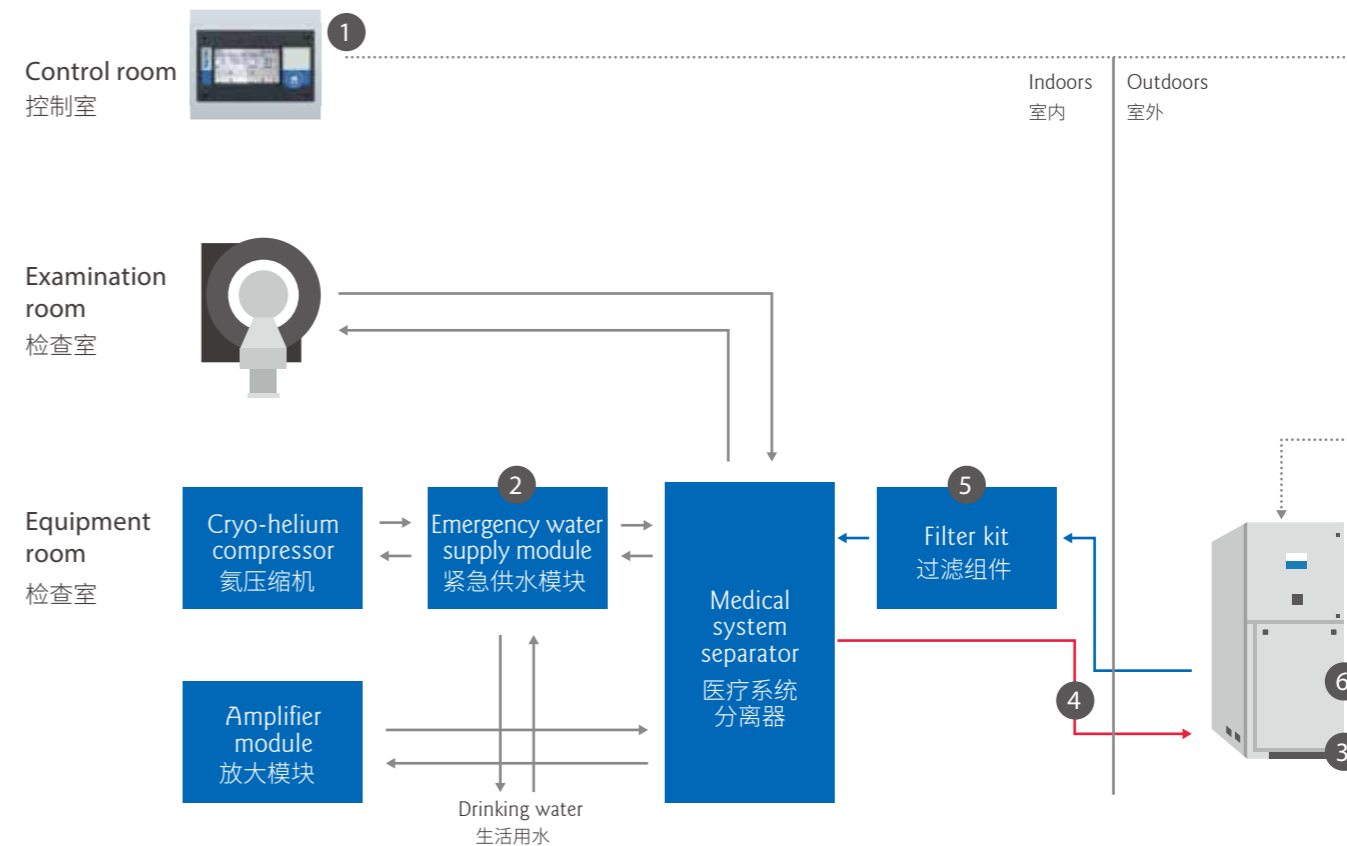

# AFTER SERVICE

## 售后服务

### LIFECYCLE MANAGEMENT

#### 生命周期管理

Designed for maximum performance and minimum operating costs

Safety



安全

Safety

Lifecycle Management



生命周期管理

Lifecycle Management

RIEDEL Care – Packages for MC Chillers tailored for your requirements:

#### Service module

Installation & Commissioning 安装调试	24/7 technical phone support 全天电话技术支持
Preventative maintenance 防护检修	Corrective maintenance 故障检修
Quality assurance 品质保证	Safety checks 安全排查
Spare parts 备件服务	Defined response time 快速反应时间
Remote maintenance 远程维护	Warranty extension 延保服务

### OPERATING DISPLAY INCLUDES

#### 服务支持包含

RIEDEL 7\*24 小时服务  
Free 24/7 hotline in your local language\*

热线 +86 24 83780248

可提供远程电话支持

Remote telephone support is available

请把如下信息告知客服：产品型号 / 序列号 / 故障描述

Contact support and forwarding of information:  
Unit type/serial number, fault description  
Technical support over the phone

支持语言：中文、英文

Currently available in CN and EN You can see the up-to-date list of countries at [www.gdts-one.cn](http://www.gdts-one.cn).

实现生命周期内最佳性能，最少运行费用

Achieve the best performance in the life cycle with minimum operating costs



定期的产品保养  
Regular product maintenance



现场维修  
On site maintenance



远程诊断  
Remote diagnosis



可实现早期检测，提前预防故障发生  
It can realize early detection and prevent failure in advance